

Haier

SPLIT TYPE ROOM AIR CONDITIONER OPERATION MANUAL



Model: AS12JB3LRA/1U12MY1QRA
AS18JD3LRA/1U18MY1QRA
AS12JB4LRA/1U12MY4QRA
AS18JD4LRA/1U18RY4QRA
AS12JB4HRA/1U12MY4ERA
AS18JD4HRA/1U18RY4ERA
AS12JB4HRA/1U12BY1ERA
AS18JD4HRA/1U18JY1ERA
HSU-12JS5(DCINV)
HSU-12JW3(DCINV)
HSU-19JS5(DCINV)
HSU-19JW3(DCINV)
HSU19P-JS5B(INV)
HSU12P-JW3B(INV)
HSU19P-JW3B(INV)

- Please read this operation manual before using the air conditioner.
The appearance of the machine is in accordance with material object.
Keep this operation manual for future reference.

Dear Haier users,

Thank you for choosing and using Haier products.

Haier products have high quality and excellent performance. For your convenience, please read the operation manual carefully, and follow the instructions to operate. Haier's "international star service" will accompany you from the beginning to end, so please feel free to contact the 24-hour service phone directly whenever you meet problems during the use. We are always at your service.

Visual air quality function

This product has built-in dust sensor and humidity sensor, which can detect the humidity and quality of the indoor ambient air intelligently. It gives alarm when the PM2.5 exceeding the standards with the lamp belt turning red which shall be green under normal conditions. It can realize accurate judgment, and enable you to learn about the air conditions in your house at all times.

PM2.5 removal function

This product has two methods to remove particle pollutants with one using HE PA high-efficiency dust removal filter to remove PM2.5 and PM10 etc. powerfully, and the other one using international leading IFC light ion high-efficiency dust collection technology to remove PM0.3 and PM2.5 etc. powerfully. They show not only significant effects, but also high safety relying on the automatic detection, reminder and removal functions. However, the two functions cannot be used simultaneously.

WiFi function

This product can realize remote control, operation, management, energy consumption query, sleep curve setting and other functions through WiFi to have the users enjoy comfortable temperature quietly. Equipment needing to be provided by the users: smart phone with Android or IOS operating system, and wireless router (needing to be connected to the Internet).

Self-cleaning function

This product can have frost or condensate water formed on surfaces of the indoor and outdoor heat exchangers to clean the surface dust through controlling the temperature of the indoor heat exchangers of the control room. Through adding antibacterial silver ions to the surface coatings of the indoor and outdoor heat exchangers, self-cleaning of the indoor heat exchangers can be achieved.

Smart Humidity function

This product has built-in temperature and humidity sensor, which can detect the indoor temperature and relative humidity. By smart humidity function, it can provide customer the comfortable temperature and humidity condition, and inhibit the growth of bacteria and fungi in the room.

Quiet function

Haier air conditioner has quiet function to have the machine operate quietly.

Table of Contents:

Instructions before Use	Name of the Parts	3
	Loading of the battery	8

Using the Air Conditioner	Automatic Air Conditioning (Power on/off, cooling, heating, purifying and fan speed regulation)	9
	Thermoregulation, Fan Speed Regulation and Purifying Function	10
	Swing, Smart Function and Smart Humidity Function	11
	Health Airflow Function	12
	FAN Mode, Light, Lock, Air Status, Wifi and Code Function	13
	Self-Clean Function	14
	Turbo Operation/Quiet Operation	15
	Timer and Confirm/Cancel Function	16
	Sleep Function	17
	Sleep Quiet Function	18

Customer Support	Care and Cleaning	18
	Cautions	20
	Installation Instructions	22
	Wi-Fi function description	29
	E-waste Guideline Manual	30

Name of the parts

Indoor unit and LCD display

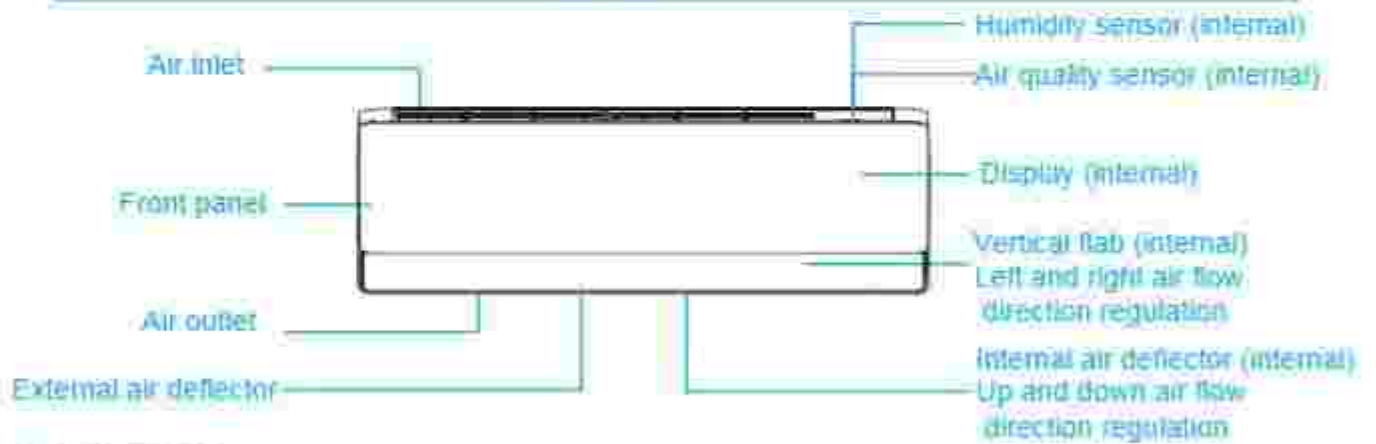

Note: Note the panel display of some mode is as the above picture.



Note: As per the different test method, the PM2.5 app displaying may be different from Ministry of Environment announcement or other measurement devices.

The operation mode symbol displays the corresponding color when setting:
 Cooling: blue Heating: rosy Drying: blue
 Good air quality: Air quality light turns green
 Bad air quality: Air quality light turns red
 Warning air quality: Air quality light turns yellow

Outdoor unit

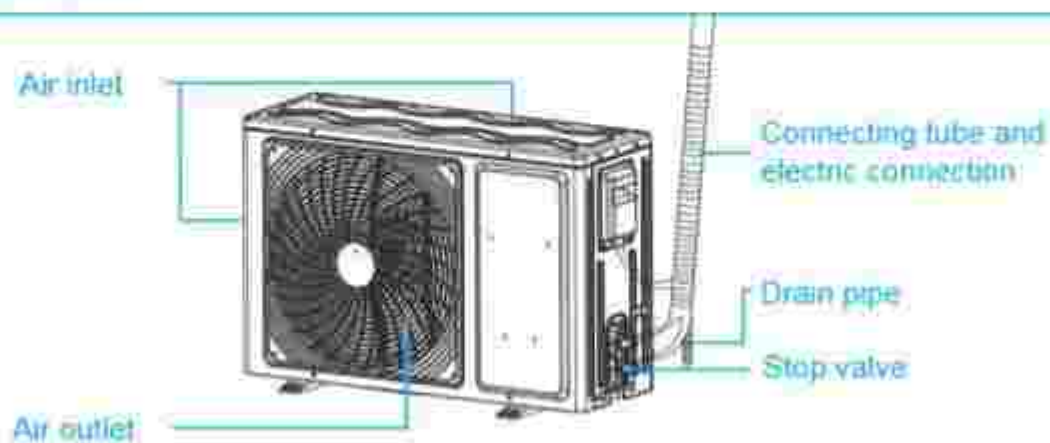

Remote controller for single cooling type AC (outer side)

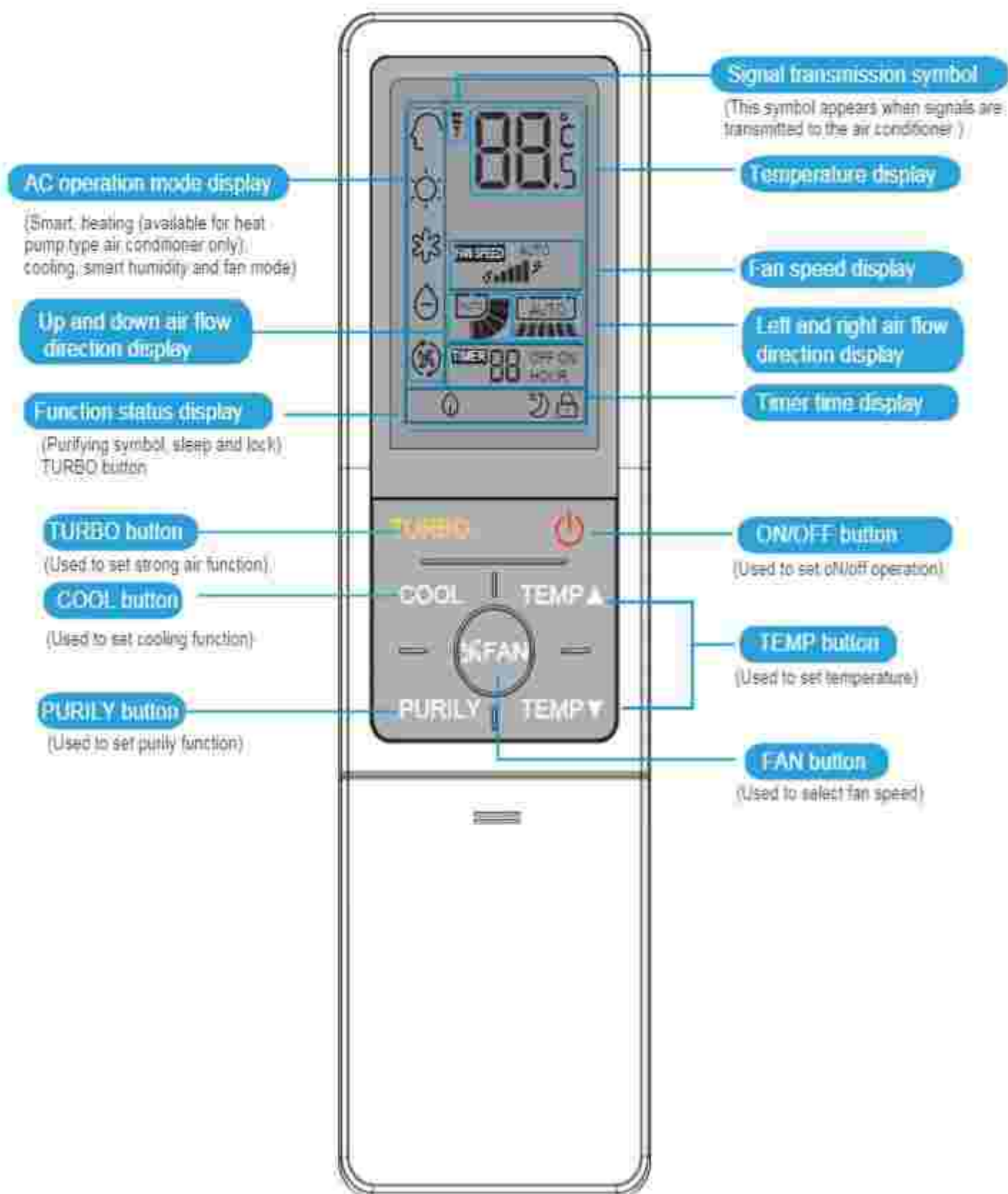

Remote controller for single cooling type AC (inner side)

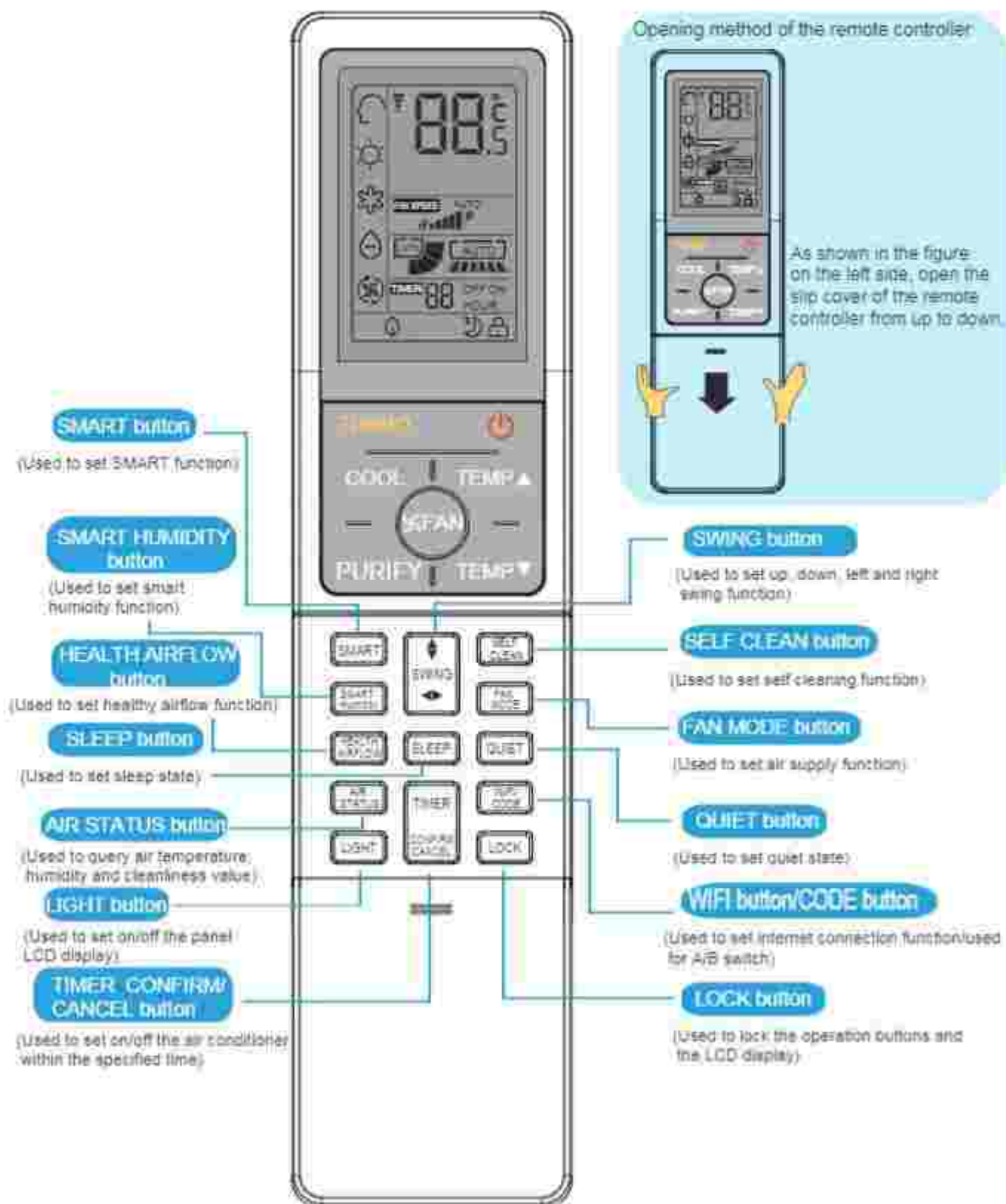

Remote controller for heat pump type AC (outer side)

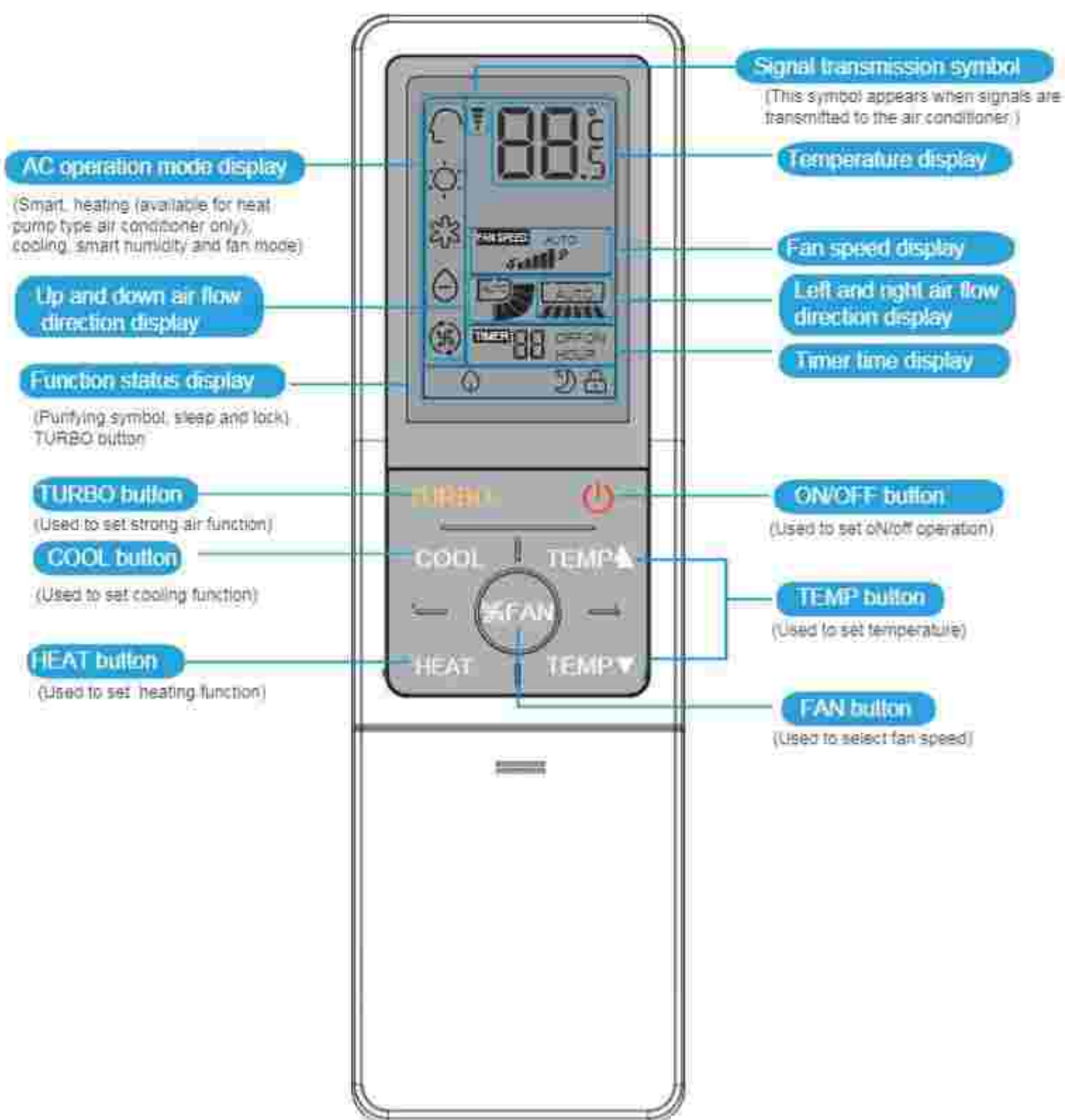

Remote controller for heat pump type AC (inner side)

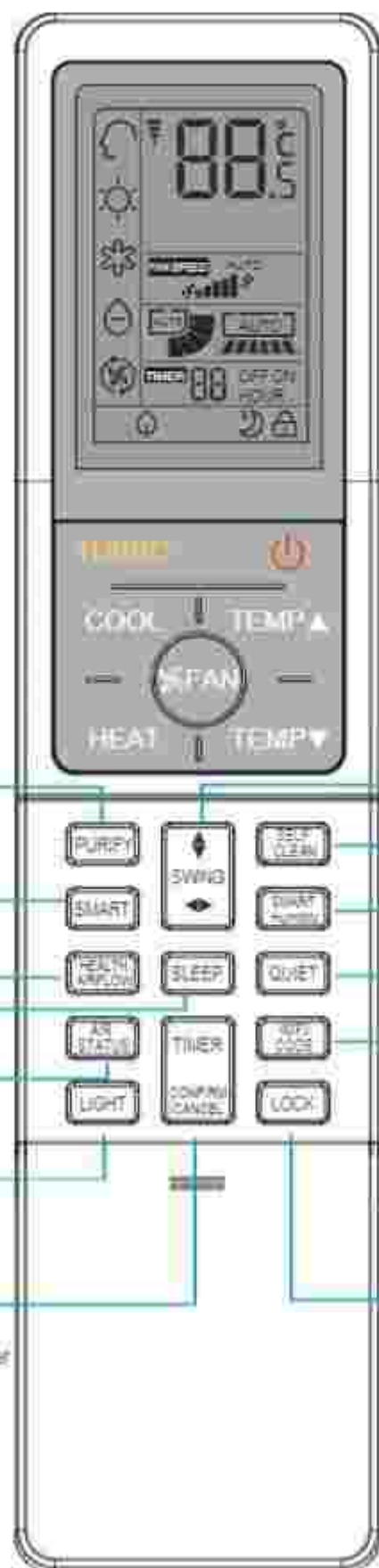

Opening method of the remote controller



As shown in the figure on the left side, open the slip cover of the remote controller from up to down

PURIFY button

(Used to set the purifying function)

SMART button

(Used to set SMART function)

HEALTH AIRFLOW button

(Used to set healthy airflow function)

SLEEP button

(Used to set sleep state)

AIR STATUS button

(Used to query air temperature, humidity and cleanliness value)

LIGHT button

(Used to set on/off the panel LCD display)

TIMER CONFIRM/CANCEL button

(Used to set on/off the air conditioner within the specified time)

SWING button

(Used to set up, down, left and right swing function)

SELF CLEAN button

(Used to set self cleaning function)

SMART HUMIDITY button

(Used to set smart humidity function)

QUIET button

(Used to set quiet state)



WIFI button/CODE button

(Used to set internet connection function/used for A/B switch)

LOCK button

(Used to lock the operation buttons and the LCD display)

Loading of the battery

-  Remove the battery cover.
-  Load the batteries as illustrated. 2 R-03 batteries, resetting key (cylinder);
Be sure that the loading is in line with the "+"/"-";
-  Load the battery, then put on the cover again.

Note:

The distance between the signal transmission head and the receiver hole should be within 7m without any obstacle as well. When electronic-started type fluorescent lamp or change-over wireless telephone is installed in the type fluorescent lamp or room, the receiver is apt to be disturbed in receiving the signals, so the distance to the indoor unit should be shorte

Full display or unclear display during operation indicates the batteries have been used up. Please change batteries.
If the remote controller can't run normally during operation, please remove the batteries and reload several minutes later

Introduction to the main functions of this product

Automatic air conditioning (Power on/off, cooling, heating (available for heat pump model only), purifying and fan speed)

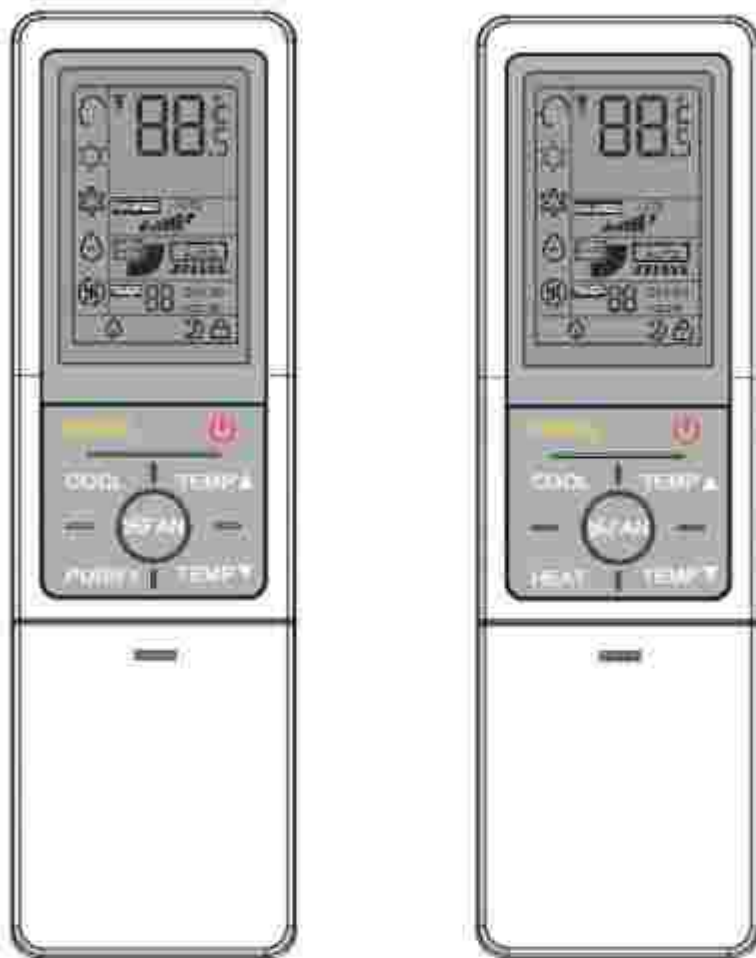

1. **Power** button
Used to set ON/OFF operation.
2. **COOL** button
Used to set COOL operation.
3. **HEAT** button
Used to set HEAT operation.
2. **FAN** button
Used to set FAN operation.
4. **TURBO** button
Used to set TURBO operation.
5. **PURIFY** button
Used to set PURIFY operation.

Use remote control to turn on and display setting temperature 24

Tips

- While cooling, as the cold air condenses downward, horizontal air flow direction regulation is more conducive to air circulation in the room.
- While heating, as the hot air condenses upward, inclined downward air flow direction regulation is more conducive to air circulation in the room.

Warm Prompt

- Do not move the air deflectors with hands directly, or the air deflectors may not be able to close normally, and the precision parts may be damaged.
- If the air deflectors cannot close normally, you can shut down the machine and cut off the power once, and then plug in the power plug again to have the air deflectors automatically reset.
- In case of high humidity, if the vertical flaps swing all to the left or right, there may be water dripping from the air outlet.
- During cooling or drying operation, the air deflectors had better not be placed in the downward position for a long time period so as to avoid condensation at the air outlet.

Thermoregulation, Fan Speed Regulation and Purifying Function

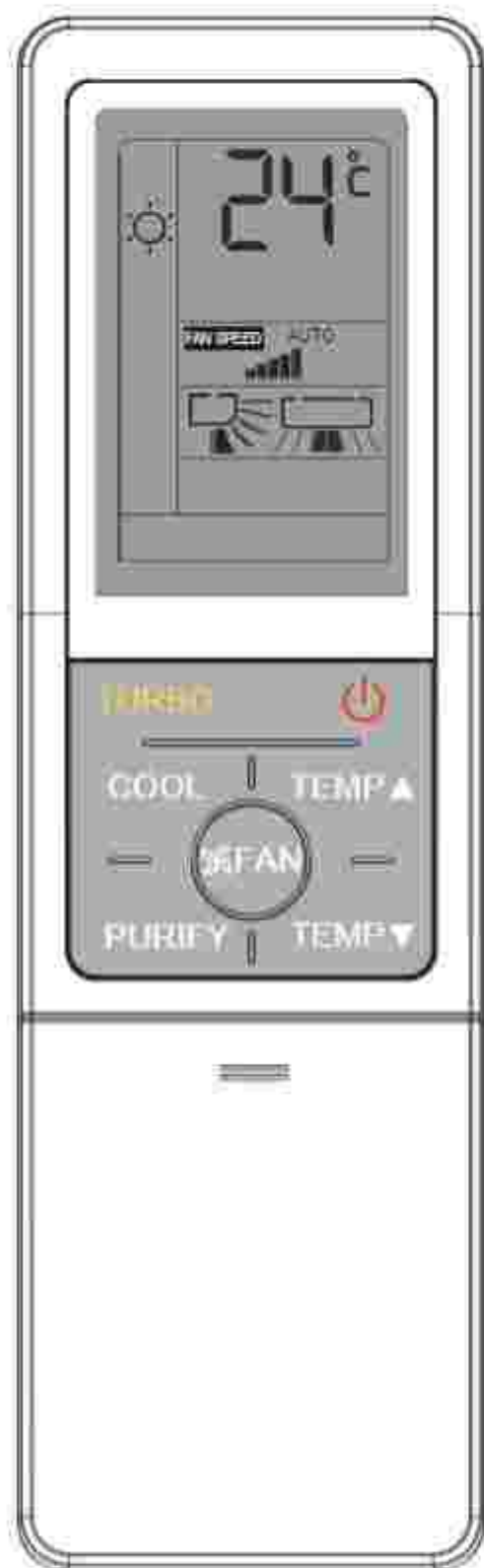

Thermoregulation :

TEMP▲button Every time the button is pressed, temp. setting increases 0.5°C.

TEMP▼button Every time the button is pressed, temp. setting decreases 0.5°C.

Note: Unit will start running to reach the temp. setting on LCD.



Press FAN button. For each press, fan speed changes as follows:

FAN :



Note: In the fan mode, only high, medium and low fan speed options are available, and no automatic fan speed is available.



Purifying Function:

IFD filter:

In the cooling/heating/smart humidity/fan mode, if you press down the PURIFY button of the remote controller, the dust removal filter will slide to the working position within three minutes and start purifying. In the smart operation mode, the product will determine whether the purifying function needs to be turned on or not automatically according to the PM2.5 concentration value actually detected by the indoor air quality sensor. If yes, then the purifying function will turn on automatically. When the PM2.5 concentration drops to a certain value, the purifying function will turn off automatically and you do not need to press the remote controller.

Exit method

While the air conditioner is operating in the purifying mode, if you press down the PURIFY button, then the purifying function will be cancelled and the dust removal filter will slide back its original position.

Matters needing attention:

1. When the purifying function is turned on, due to the sliding of the dust removal filter, slight noise may be generated and this is a normal phenomenon.
2. If the air quality indicator light still shows red after the purifying has been operated for a long time period, we recommend you to clean the dust removal filter.
3. In the purifying mode, low fan speed operation will affect the purifying effects.
4. You cannot enter the purifying mode from the self-cleaning mode directly.
5. The purifying module of this product has transmission mechanism, so please do not switch on and off the purifying function frequently.

Swing, Smart Function and Smart Humidity function

You can select your preferred air flow direction by moving the up, down, left and right flaps.

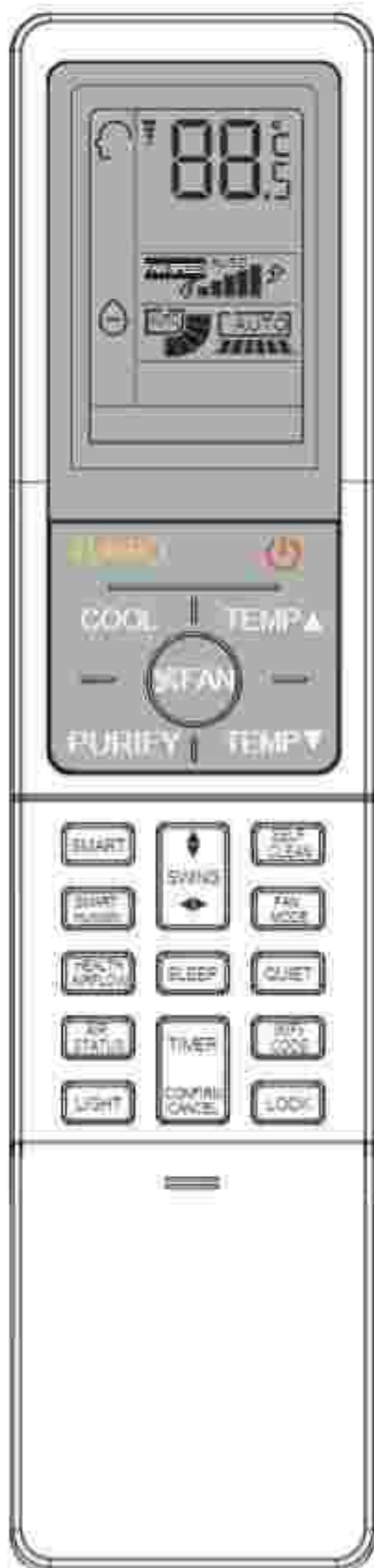

Up and down air flow direction

For each press of "SWING" button, air flow direction on remote controller displays as follows according to different operation modes:



Left and right air flow direction

For each press of "SWING" button, remote controller displays as follows: remote controller:

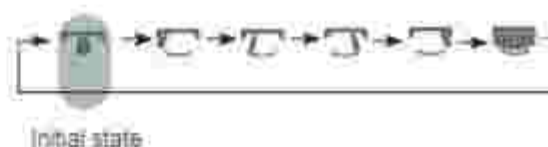

SMART function

Press ON/OFF button, unit starts. Press SMART button "SMART" is displayed on the remote controller.

Air conditioning will automatically select Cool / Heat / FAN mode.



Smart Humidity function



Press the smart humidity button, set the temperature (16 - 30 °C), set the fan speed as AUTO / high / medium / low. The air conditioner can adjust its dehumidification operation to provide customer with comfortable experience of temperature and humidity (there maybe some deviation in relative humidity measurement, it is for reference).

Note: Some models do not have this function.

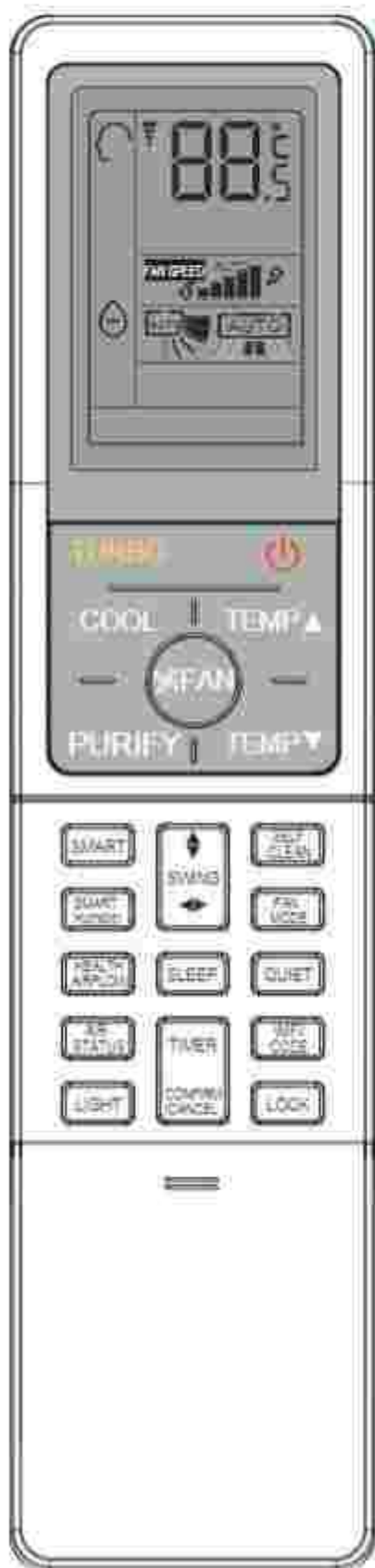
Health Airflow function



The setting of health airflow function

- 1). Press the button of health airflow,  appears on the display. Avoid the strong airflow blows direct to the body.
- 2). Press the button of health airflow again,  appears on the display. Avoid the strong airflow blows direct to the body.

The cancel of the health airflow function



Press the button of health airflow again, both the inlet and outlet grills of the air conditioner are opened, and the unit goes on working under the condition before the setting of health airflow function. After stopping, the outlet grille will close automatically.

Notice:

Cannot pull direct the outlet grille by hand. Otherwise, the grille will run incorrectly. If the grille is not run correctly, stop for a minute and then start, adjusting by remote controller.

Remote controller can memorize each operation status, when starting it next time, just press ON/OFF button and unit will run in previous status.

Note:

1. After setting the health airflow function, the position of inlet and outlet grills is fixed.
2. In heating, it is better to select the  mode.
3. In cooling, it is better to select the  mode.
4. In cooling and dry, using the air conditioner for a long time under the high air humidity, a phenomenon falling drips of water occurs at the outlet grille.
5. Select the appropriate fan direction according to the actual conditions.

Fan Mode, Light, Lock, Air Status, WIFI and Code Function



Fan mode function

Fan mode: default low fan speed, fan mode, the setting temperature will not display, the temperature of indoor display is 24



LIGHT function

Control the lightening and extinguishing of the indoor LED display board.



LOCK function

Press the button of the LOCK, "Ⓔ" appears on the display. Avoid children to operate the remote controller. Press the button of the LOCK again, "Ⓔ" disappears. Then the remote controller can be operated.



AIR STATUS function

- 1 Press down the query button, it will display ambient temperature for 5 seconds.
- 2 when it display the ambient temperature, press the query button again, it will display the humidity for 5 seconds.
- 3 when it display the relative humidity, press the query button again, it will display the value of PM 2.5 concentration for 5 seconds.

Note: Time intervals of continuous button pressing shall be less than 5s



WiFi - APP control function

See the last page for the specific content of this function. Press down the button and hold it until the AC enter into the process of WiFi setting.

Note: Some models do not have this function



CODE- Signal conversion function

Used to control the operations of multiple air conditioners simultaneously and to control A/B code sending and switching function.

Self-clean Function



SELF CLEAN function

• Description of the function:

The purpose of this function is to clean the indoor heat exchanger.

• Entry method:

Entry method: Press the button of SELF CLEAN to enter the function, and the air conditioner conducts self-cleaning for the indoor heat exchanger.

After entering the function, repeated pressing of the button is invalid, and the whole cycle lasts for 13-24 minutes.

Entry display:

1. The host panel displays "CL", indicating that the function is operating.

2. "CL" is displayed after the remote controller is set.

Exit method:

1. Press the button of OFF or switch to other modes to exit; during operation, other buttons cannot be used.

2. After completion of self-cleaning, the air conditioner exits automatically and returns to the original condition; the host makes a sound of "P" twice.

Matters needing attention:

1. After entering the self-cleaning function, the indoor air volume will decrease or no wind will blow out; and the fan may stop, but the compressor won't stop.

2. During the operation, the indoor unit conducts self-cleaning, and there may be cold air blowing out.

3. During the self-cleaning, the heat exchanger may have frost formed accompanied by poop sound; the connecting pipe and valves of the outdoor unit may also have frost formed.

4. To enhance the cleaning effects, the air deflectors may be in different positions and the remote controller cannot be used.

5. Depending on the different working environment of the

outdoor unit, cleaning effects of the heat exchanger may vary.

6. During the self-cleaning process, water will be discharged from the indoor drain pipe and the outdoor drain hole.

7. The duration of the remote controller and the panel displaying "CL" may vary.

Turbo Operation

When you need to cool or heat rapidly, you can use this function.



For each press, "TURBO" is displayed. Air conditioner starts TURBO function operation. In TURBO operation mode, fan speed automatically takes low speed of AUTO fan mode.

Press TURBO button again, "TURBO" disappears, the operation stops.

Quiet Operation

When you want to rest, read or want the environment to be quiet, you can use this function.



For each press, "QUIET" is displayed. Air conditioner starts QUIET function operation. In QUIET operation mode, fan speed automatically takes low speed of AUTO fan mode.

Press QUIET button again, "QUIET" disappears, the operation stops.

Tips:

In cooling and heating mode, pressing the button of TURBO can improve the cooling and heating effects.

If cooling for a long time under quiet operation, condensation and water will be generated.

Timer and Confirm/cancel Function



- 1 Press the button of the TIMER at the remote controller off mode.
Remote controller "TIMER ON" will flash.

Press the button of the TIMER at the remote controller on mode.
Remote controller "TIMER OFF" will flash.
- 2 Time setting
Every time the button is pressed, time setting increases or decreases 1 hour, if kept depressed, it will increase rapidly. It can be adjusted within 24 hours.
- 3 Confirming your setting.
After setting correct time, press CONFIRM button to confirm "ON" or "OFF" on the remote controller stops flashing.

Note: To cancel TIMER mode just press CANCEL button the TIMER display will disappear.

ON/OFF Operation:

- Use this operation only when the remote controller is defective or lost, and with function of emergency running, air conditioner can run automatically for a while.
- When the emergency operation switch is pressed, the "PI" sound is heard once, which means the start of this operation.
- When power switch is turning on for the first time and emergency operation starts, the unit will run automatically in the following modes:

Room temperature	Designated temperature	Timer mode	Fan speed	Operation mode
Above 23 °C	26 °C	No	AUTO	COOL
Below 23 °C	26 °C	No	AUTO	HEAT (for heating and heating mode) FAN (for cooling only mode)

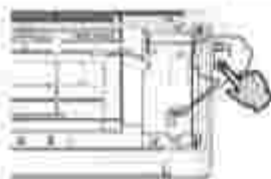

Test operation:

- Test operation switch is the same as emergency switch.
- Use this switch in the test operation when the room temperature is below 16 °C, do not use it in the normal operation.
- Continue to press the test operation switch for more than 5 seconds. After you hear the "PI" sound twice, release your finger from the switch; the cooling operation starts with the air flow speed "Hi".

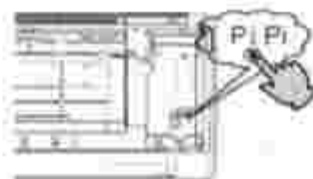

Sleep Function

Press the button of SLEEP before going to sleep, the air conditioner will enter sleep operation mode to make your sleep more comfortable.



Press SLEEP button.

Operation Mode

1. In COOL mode

1 hours after SLEEP mode starts, temp. will become 0.5°C higher than temp. setting. After another 1 hours, temp. rises by 0.5°C further. The unit will run for further 6 hours then stops. Temp. is higher than temp. setting so that room temperature won't be too low for your sleep.

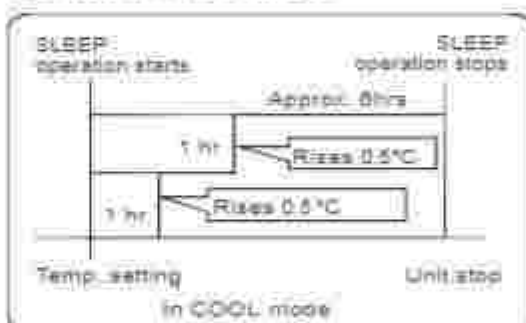

2. In HEAT mode

1 hours after SLEEP mode starts, temp will become 1°C lower than temp. setting. After another 1 hours, temp decrease by 1°C further. After more another 3 hours, temp. rises by 0.5°C further. The unit will run for further 3 hours then stops. Temp. is lower than temp. setting so that room temperature won't be too high for your sleep.

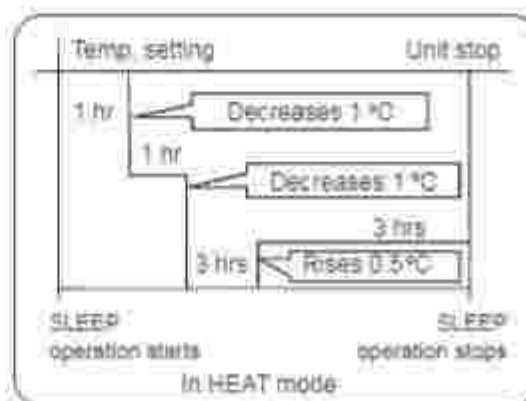

Air Filter cleaning

1 Open the inlet grille by pulling it upward.

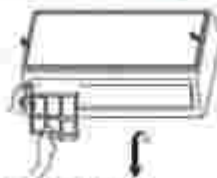

2 Remove the filter.

Push up the filter's center tab slightly until it is released from the stopper, and remove the filter downward.

3 Clean the filter.

Use a vacuum cleaner to remove dust, or wash the filter with water. After washing, dry the filter completely in the shade.

4 Attach the filter.



Attach the filter correctly so that the "FRONT" indication is facing to the front. Make sure that the filter is completely fixed behind the stopper. If the right and left filters are not attached correctly, that may cause defects.

5 Close the inlet grille.

Remote Controller



Do not use water. Wipe the controller with a dry cloth. Do not use glass cleaner or chemical cloth.

Indoor Body



Wipe the air conditioner by using a soft and dry cloth. For serious stains, use a neutral detergent diluted with water. Wring the water out of the cloth before wiping, then wipe off the detergent completely.

Do not use the following for cleaning



Gasoline, benzene, thinner or cleanser may damage the coating of the unit.



Hot water over 40°C (104°F) may cause discoloring or deformation.

Care and cleaning of IFD dust removal module

IFD dust removal module can be used all the time; generally does not need to be replaced; and can be washed. According to the actual conditions of the air conditioner, just clean it by yourself or when prompted by the APP. Additionally, clean the dust on the negative ion emitter on the right inner wall of the air duct with dry brush and other items.

When disassembling and cleaning the IFD module, cut off the power supply in advance, and wait 1 minute before removing the dust screen for cleaning!

1 Shut down the machine and switch off the power switch, hold the handle of the air inlet grilles to open them, and remove the dust screen.

2 Hold the handle on the IFD dust removal module and pull the module out.

3 After the dust removal module is taken out, place it on a flat surface and use the nozzle of the vacuum cleaner or the suction head with a brush to clean the dust along the surface of the module. Suck both sides of the module.

4 Add warm water in a basin and gently shake the module in the water to clean it.

5 Let the module soak in water for 2-3 minutes; do not take soak it for a too long time, then rinse the module with clean tap water, shake off the water in the module, and place it on a dry towel.

6 After the IFD dust removal module becoming completely dry and without water, load it into the machine, and then install the dust screen.

Notes:

1 After installation of the air conditioner, the installer shall load the IFD dust removal module into the air conditioner.

2 After cleaning, color of the module cannot restore to its original condition, but this will not affect its performance.

3 Dust removal effects of IFD relate closely to the room structure, room size and pollutants content in the room.

The effects may vary depending on different models and environments.

4 IFD dust removal module must be installed in place before operation of the machine. It is prohibited to operate the machine without installing the dust removal module.

Installation and removal of dust removal filter

1. Introduction to the mechanism (those shown in figure are only schematic diagrams of the parts; please refer to the real objects)

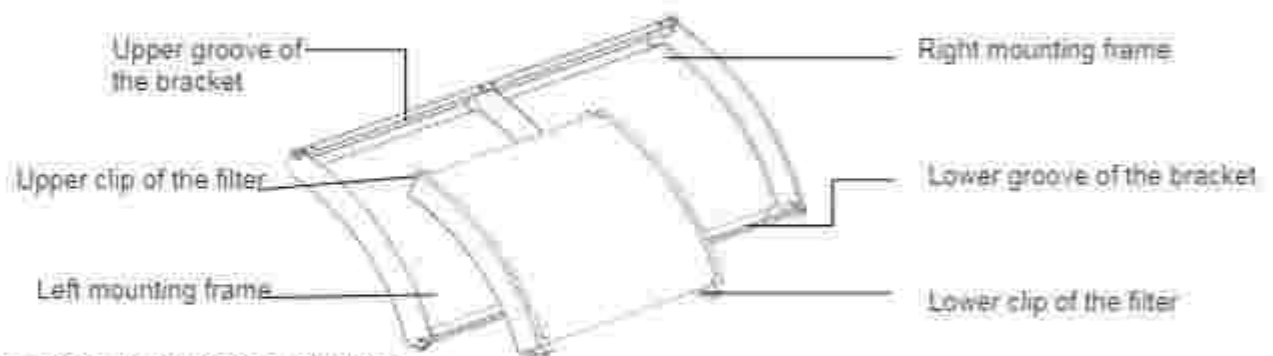

2. Mounting dust removal filter

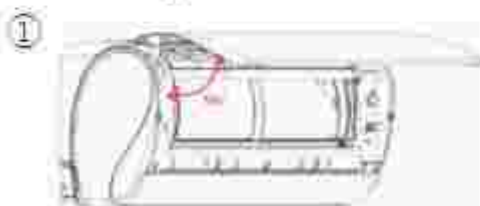

Pull out the power plug of the air conditioner, and open the panel upward at about 90° (panel will automatically get stuck).

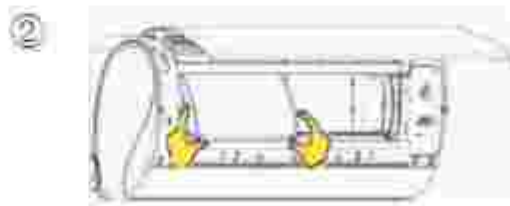

Snap the upper clip of the filter into the upper groove of the bracket, and ensure to snap it into place.

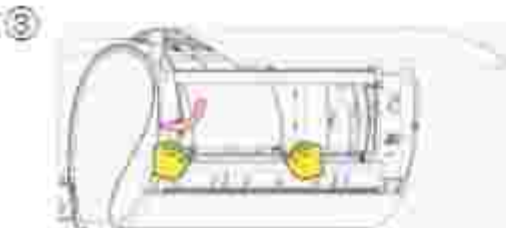

Snap the lower clip of the filter into the lower groove of the bracket, and ensure to snap it into place.

3. Removing the dust removal filter

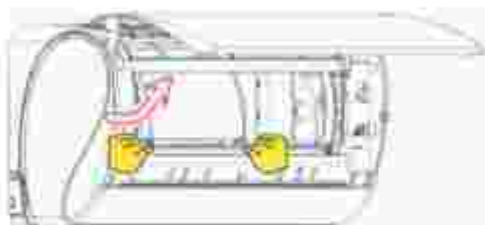

Pull the lower clip of the filter to separate the clip from the groove, and turn and pull out the filter in the direction as shown in the figure.

Note: Before removing and installing the dust removal filter, exit the air conditioner from the purifying mode, wait 5 minutes before shutting down the machine and replacing the filter. Do not directly cut off the power supply to replace the filter when the air conditioner is in purifying operation. Operating steps of the right filter are the same as those of the left one.

Cautions

⚠ WARNING

Please call Sales/Service Shop for the Installation.
Do not attempt to install the air conditioner by yourself because improper works may cause electric shock, fire, water leakage.

⚠ WARNING

When abnormality such as burnt-smell found, immediately stop the operation button and contact sales shop.



Use an exclusive power source with a circuit breaker.



Check proper installation of the drainage securely.



Connect power supply cord to the outlet completely.



Use the proper voltage.



1. Do not use power supply cord extended or connected in halfway.
2. Do not install in the place where there is any possibility of inflammable gas leakage around the unit.
3. Do not get the unit exposed to vapor or oil steam.



Do not use power supply cord in a bundle.



Take care not to damage the power supply cord.



Do not insert objects into the air inlet or outlet.



Do not start or stop the operation by disconnecting the power supply cord and so on.



Do not channel the air flow directly at people, especially at infants or the aged.



Do not try to repair or reconstruct by yourself.



Connect the earth cable.



⚠ CAUTION

Do not use for the purpose of storage of food, air work, precise equipment, breeding, or cultivation.

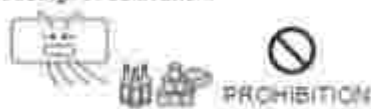

Take fresh air occasionally especially when gas appliance is running at the same time.



Do not operate the switch with wet hand.



Do not install the unit near a fireplace or other heating apparatus.



Check good condition of the installation stand.



Do not pour water onto the unit for cleaning.



Do not place animals or plants in the direct path of the air flow.







Do not place any objects on or climb on the unit.



Do not place flower vase or water containers on the top of the unit.



Before asking for service, check the following first.

	Phenomenon	Cause or check points
Normal Performance inspection	<p>The system does not restart immediately.</p> 	<ul style="list-style-type: none"> When unit is stopped, it won't restart immediately until 3 minutes have elapsed to protect the system. When the electric plug is pulled out and reinserted, the protection circuit will work for 3 minutes to protect the air conditioner.
	<p>Noise is heard</p> 	<ul style="list-style-type: none"> During unit operation or at stop, a swishing or gurgling noise may be heard. At first 2-3 minutes after unit start, this noise is more noticeable. (This noise is generated by refrigerant flowing in the system.) During unit operation, a cracking noise may be heard. This noise is generated by the casing expanding or shrinking because of temperature changes. Should there be a big noise from air flow in unit operation, air filter may be too dirty.
	<p>Smells are generated</p>	<ul style="list-style-type: none"> This is because the system circulates smells from the interior air such as the smell of furniture, paint, cigarettes.
	<p>Mist or steam are blown out.</p> 	<ul style="list-style-type: none"> During COOL operation, indoor unit may blow out mist. This is due to the sudden cooling of indoor air.
	<p>In Smart Humidity mode, fan speed can't be changed.</p>	<ul style="list-style-type: none"> In the Smart humidity mode, changing the remote fan mode, but the AC fan speed can't be changed. In the Smart Humidity mode, when the ambient temperature is near the setting temperature or the relative humidity is too low, the AC will run at LOW speed regardless of FAN setting.
Multiple check		<ul style="list-style-type: none"> Is power plug inserted? Is there a power failure? Is fuse blownout?
	<p>Poor cooling</p> 	<ul style="list-style-type: none"> Is the air filter dirty? Normally it should be cleaned every 15 days. Are there any obstacles before inlet and outlet? Is temperature set correctly? Are there some doors or windows left open? Is there any direct sunlight through the window during the cooling operation? (Use curtain) Are there too much heat sources or too many people in the room during cooling operation?

Installation instructions

Pay attention to the following points before installation of machine:

1. Remove 2 gaskets under the cross-flow fan.

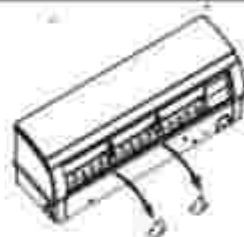

2. Clean the burr on the surface of fracture to avoid the power wire from being scratched after removing the virtual opening of the outgoing line slot on the case by hands in indoor power-on process.

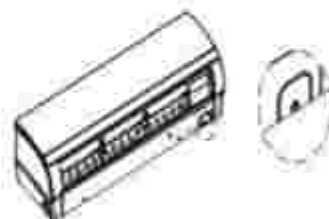

Connecting the indoor/outdoor Electric Cable

1. Remove terminal cover at right bottom corner of indoor unit, then take off wiring cover by removing its screws.
2. Insert from outside the room cable into left side of the wall hole, in which the pipe has already existed.
Pull out the cable on the front side, and connect the cable making a loop.
3. Insert the cable from the back side of the unit, then pull it out on the front side.
4. Loosen the screws and insert the cable ends fully into terminal block, then tighten the screws.
5. Pull the cable slightly to make sure the cables have been properly inserted and tightened.
6. After the cable connection, never fail to fasten the connected cable with the wiring cover.
When connecting the cable, confirm the terminal number of indoor and outdoor units carefully. If wiring is not correct, proper operation can not be carried out and will cause defect.

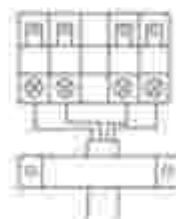
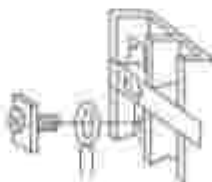

Drawing of pipe

[Rear piping]

- Draw pipes and the drain hose, then fasten them with the adhesive tape

[Left · Left-rear piping]

- In case of left side piping, cut away, with a nipper, the lid for left piping.
- In case of left-rear piping, bend the pipes according to the piping direction to the mark of hole for left-rear piping which is marked on heat insulation materials.

1. Insert the drain hose into the dent of heat insulation materials of indoor unit.
2. Insert the indoor/outdoor electric cable from backside of indoor unit, and pull it out on the front side, then connect them.
3. Coat the flaring seal face with refrigerant oil and connect pipes.
Cover the connection part with heat insulation materials closely, and make sure fixing with adhesive tape

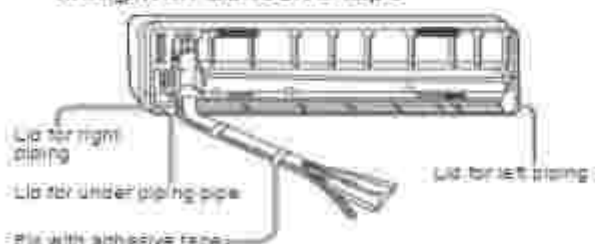

- Indoor/outdoor electric cable and drain hose must be bound with refrigerant piping by protecting tape.

[Other direction piping]

- Cut away, with a nipper, the lid for piping according to the piping direction and then bend the pipe according to the position of wall hole. When bending, be careful not to crash pipes.
- Connect beforehand the indoor/outdoor electric cable, and then pull out the connected to the heat insulation of connecting part specially.

Fixing the indoor unit body

- Hang surely the unit body onto the upper notches of the mounting plate. Move the body from side to side to verify its secure fixing.
- In order to fix the body onto the mounting plate, hold up the body aslant from the underside and then put it down perpendicularly.

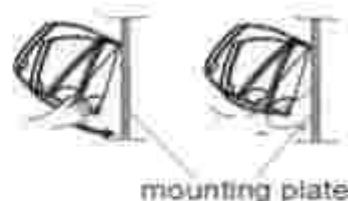

Unloading of indoor unit body

- When you unload the indoor unit, please use your hand to anse the body to leave agraffe, then lift the bottom of the body outward slightly and lift the unit aslant until it leaves the mounting plate.

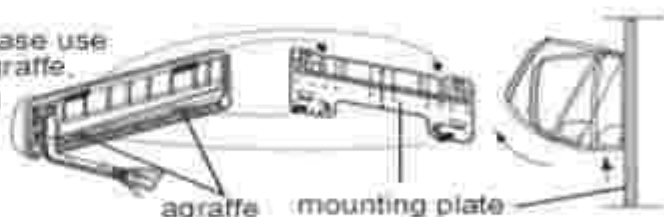

Installation instructions

Piping layout for indoor unit

Arrange the connecting pipe, drain hose and connecting line according to the mounting positions of the indoor unit, outdoor unit and through-wall hole selected; the drain hose shall be placed below and the connecting line shall be placed on top; the power line and the connecting line shall not be intertwined. The drain pipe (especially indoor and inside and the machine) must be wrapped with thermal insulation materials for insulation treatment.

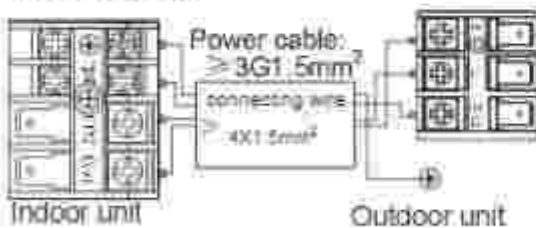

Note: 1. If the outdoor unit uses three-position terminal block, ground the unit as shown in Figure : connect the ground wire to the iron sheet at the place where there is a grounding symbol.
2. If the outdoor unit uses four-position terminal block, ground the unit as shown in Figure : connect the ground wire to the grounding position of the terminal block.

Selection of pipe

NOTE: The thickness of the pipe must be in line with the following table.

Pipe Diameter	Thickness
Liquid side 6 mm	0.53mm
Liquid/Gas side 9 mm	0.7mm
Gas side 12 mm	0.8mm

Mounting distance of outdoor unit

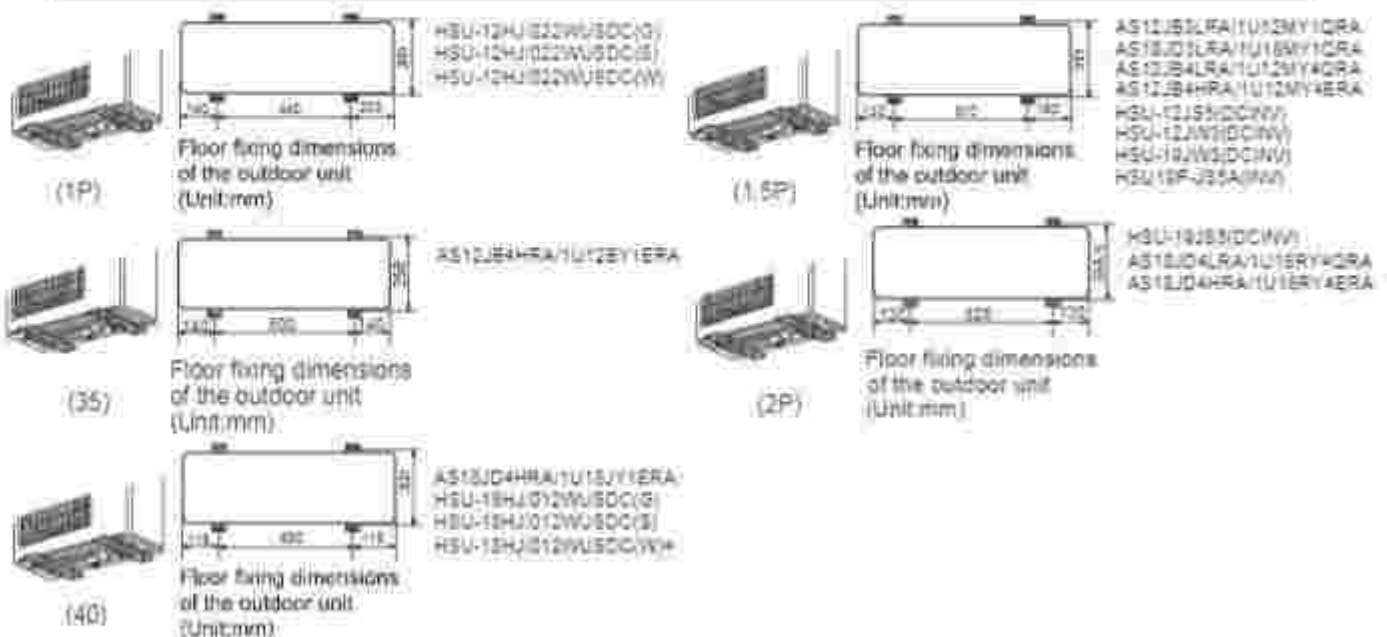

Installation of Outdoor Unit

Connection of pipes

- To bend a pipe, give the roundness as large as possible not to crush the pipe, and the bending radius should be 30 to 40 mm or longer.
- Connecting the pipe of gas side first makes working easier.
- The connection pipe is specialized for R410A/R32.

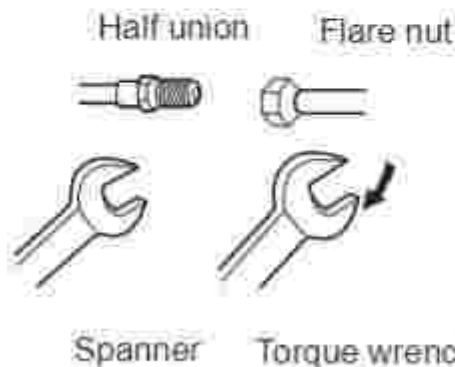

Forced fastening without careful centering may damage the threads and cause a leakage of gas.

Pipe Diameter(ϕ)	Fastening torque
Liquid side 6 mm	18N.m
Liquid/Gas side 9 mm	42 N.m
Gas side 12 mm	55N.m

Be careful that matters, such as wastes of sands, etc. shall not enter the pipe. The standard pipe length is 5m. If it is over 7m, the function of the unit will be affected. If the pipe has to be lengthened, the refrigerant should be charged according to 20 g/m. But the charge of refrigerant must be conducted by professional air conditioner engineer. Before adding additional refrigerant, perform air purging from the refrigerant pipes and indoor unit using a vacuum pump, then charge additional refrigerant.

CAUTION

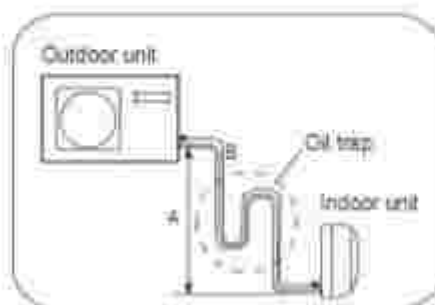
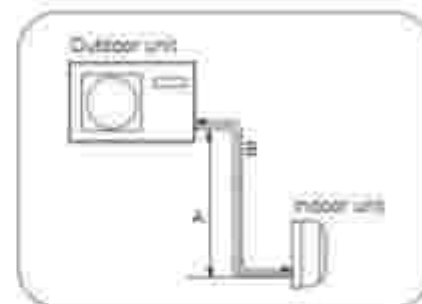
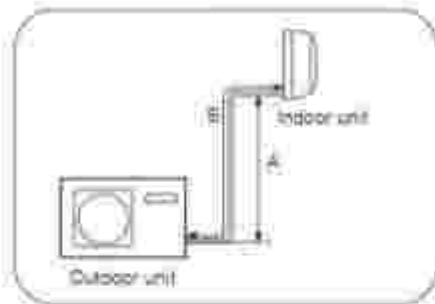

- Max. Elevation: 09-18K, Amax=10m
- In case the elevation A is more than 8m, oil trap should be installed every 5~7m
- Max. Length: 09-18K, Bmax=15m
- In case the pipe length B is more than 7m, the refrigerant should be charged, according to 20 g/m for 09-18K and 50g/m for 24K.

Connection

- Use the same method on indoor unit. Loosen the screws on terminal block and insert the plugs fully into terminal block, then tighten the screws.
- Insert the cable according to terminal number in the same manner as the indoor unit.
- If wiring is not correct, proper operation can not be carried out and controller may be damaged.
- Fix the cable with a clamp.

Attaching Drain-Elbow

- If the drain-elbow is used, please attach it as figure. (Note: Only for heat pump unit.)

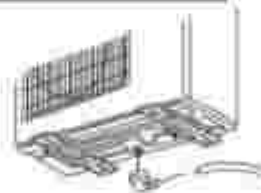

Purging Method: To use vacuum pump

- Detach the service port's cap of 3-way valve, the valve rod's cap for 2-way valve and 3-way's, connect the service port into the projection of charge hose (low) for gaugemanifold. Then connect the projection of charge hose (center) for gaugemanifold into vacuum pump.
- Open the handle at low in gaugemanifold, operate vacuum pump. If the scale moves of gauge (low) reach vacuum condition in a moment, check 1. again.
- Vacuumize for over 15min. And check the level gauge which should read -0.1MPa (76 cm Hg) at low pressure side. After the completion of vacuumizing, close the handle 'Lo' in gaugemanifold and stop the operation of the vacuum pump. Check condition of the scale and hold it for 1-2min. If the scale moves back in spite of tightening, make flaring work again, the return to the beginning of 3.
- Open the valve rod for the 2-way valve to an angle of anticlockwise 90 degrees. After 6 seconds, close the 2-way valve and make the inspection of gas leakage.
- No gas leakage?

In case of gas leakage, tighten parts of pipe connection. If leakage stops, then proceed 6. steps

If it does not stop gas leakage, discharge whole refrigerants from the service port. After flaring work again and vacuumize, fill up prescribed refrigerant from the gas cylinder.

- Detach the charge hose from the service port, open 2-way valve and 3-way. Turn the valve rod anticlockwise until hitting lightly.
- To prevent the gas leakage, turn the service port's cap, the valve rod's cap for 2-way valve and 3-way's a little more than the point where the torque increases suddenly.
- After attaching the each caps, check the gas leakage around the caps.

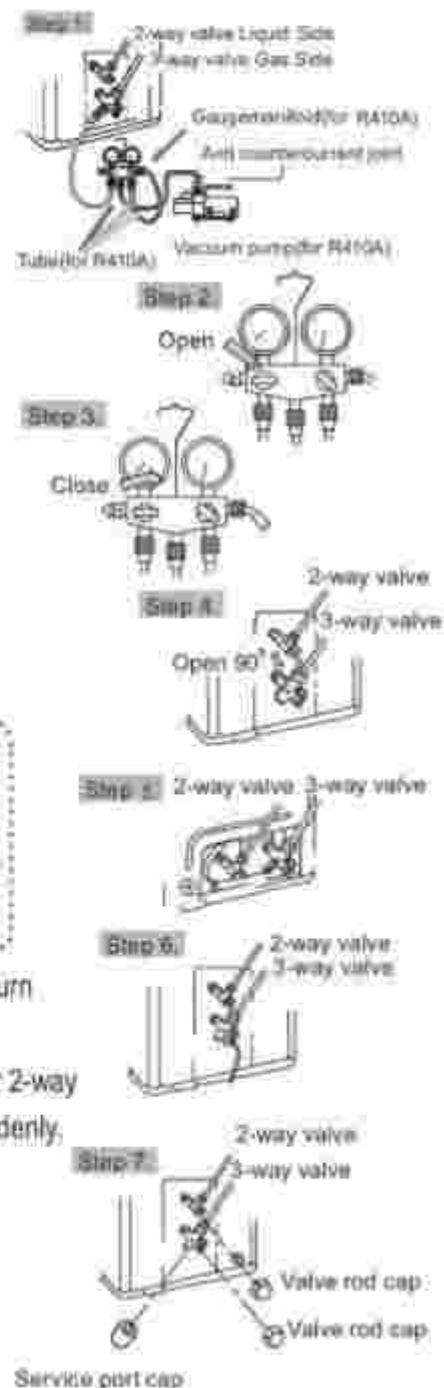

Drawing for the installation of indoor and outdoor units

- The marks from (A) to (G) in the figure are the parts numbers.
- The distance between the indoor unit and the floor should be more than 2m.

Optional parts for piping

- (A) Non-adhesive tape
- (B) Adhesive tape
- (C) Saddle (L/S) with screws
- (D) Connecting electric cable for indoor and outdoor
- (E) Drain hose
- (F) Heating insulating material
- (G) Piping hole cover

The models adopt HFC free refrigerant R410A/R32.

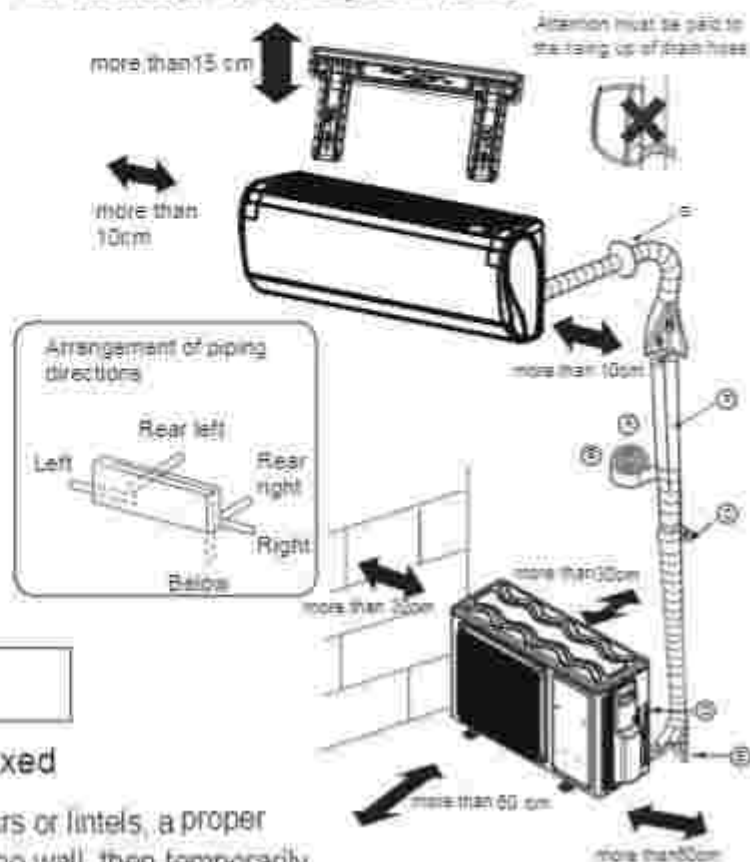

indoor and outdoor units

When the mounting plate is first fixed

1. Carry out, based on the neighboring pillars or lintels, a proper leveling for the plate to be fixed against the wall, then temporarily fasten the plate with one steel nail.
2. Make sure once more the proper level of the plate, by hanging a thread with a weight from the central top of the plate, then fasten securely the plate with the attachment steel nail.
3. Find the wall hole location A using a measuring tape

Making a Hole on the Wall and Fitting the Piping Hole Cover

1. Make a hole of 60 mm in diameter, slightly descending to outside the wall.
2. Install piping hole cover and seal it off with putty after installation.

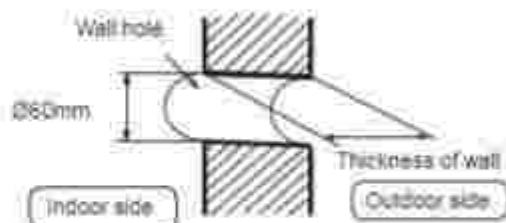
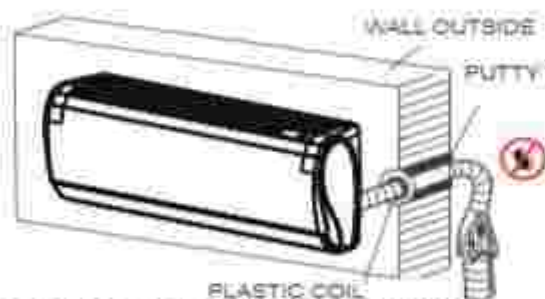

(Section of wall hole)

(G) Piping hole pipe

Instruction for Installation technician

1. Air Conditioner installed is technical job which requires better techniques. So it is recommended to choose Haier authorized installation technicians. If installation done unauthorized persons, Haier is not responsible for consequences.
2. After AC installation, fill the Hole created on wall with Putty powder & cover it with plastic Cap, So that no insect can enter through wall opening. Ensure opening is completely & properly sealed. (As shown above image)

CAUTION

1. If the refrigerant of the air conditioner leaks, it is necessary to discharge all the refrigerant. Vacuumize first, then charge the liquid refrigerant into air conditioner according to the amount marked on the name plate.
2. Please do not let other cooling medium, except specified one (R410A/R32), or air enter into the cooling circulation system. Otherwise, there will be abnormal high pressure in the system to make it crack and lead to personal injuries.

Power Source Installation

1. The power source must be exclusively used for air conditioner. (Over 10A)
2. In the case of installing an air conditioner in a moist place, please install an earth leakage breaker.
3. For installation in other places, use a circuit breaker as far as possible.

Cutting and Flaring Work of Piping

1. Pipe cutting is carried out with a pipe cutter and burs must be removed.
2. After inserting the flare nut, flaring work is carried out.

	Flare tool for R410A/R32	Conventional flare tool	
	Clutch-type	clutch-type(Rigid-type)	Wing-nut type (Imperial-type)
A	0~0.5mm	1.0~1.5mm	1.5~2.0mm

Flare tooling die

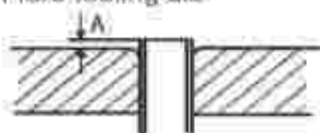

1. Cut pipe



2. Remove burs



3. Insert the flare nut



4. Flare pipe

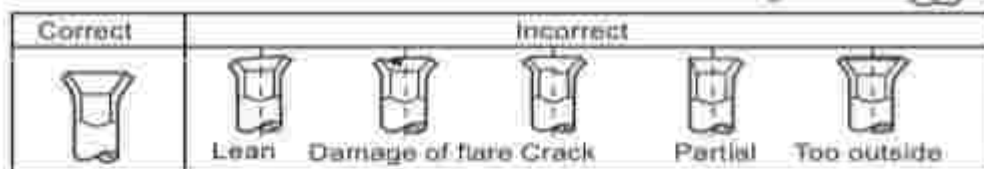

On Drainage

1. Please install the drain hose so as to be downward slope without fail.
2. Please don't do the drainage as shown below.

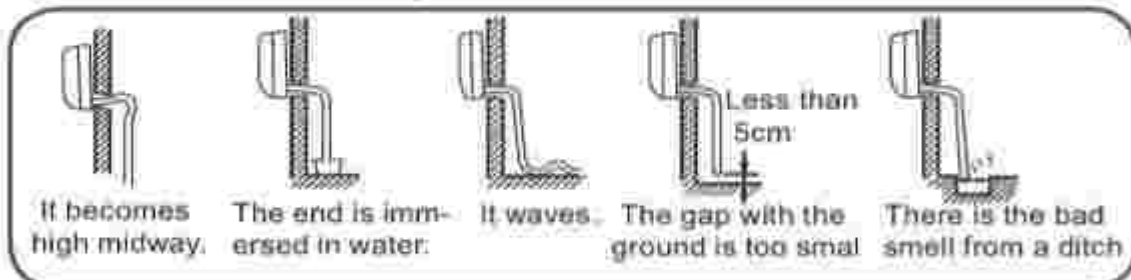

1. Please pour water in the drain pan of the indoor unit, and confirm that drainage is carried out surely to outdoor.
2. In case that the attached drain hose is in a room, please apply heat insulation to it without fail.

Wi-Fi function description

The system architecture diagram



The application environment

Smart mobile phone and wireless router are needed, wireless router need to be able to connect Internet.

Smart mobile phone requires IOS or Android system:



IOS system
Need support IOS9.0 or above.



Android system
Need support Android 5.0 or above.

Configuration method

Scan the QR code below to download "Haier Smart" APP.

Also can go to the internet application store such as App Store(IOS) or GooglePlay(Android) search "Haier Smart" APP to download

After downloading the APP, we need register and combine the air conditioner, then we can operate the air conditioner.



Scan QR code, Download APP

SIMPLIFIED EU DECLARATION OF CONFORMITY

Hereby, Qingdao Haier Technology Co.,Ltd declares that the radio equipment type WiFi Module is in compliance with Directive 2014/53/EU. There are no restrictions of use.



Support Standards:	IEEE 802.11b, IEEE 802.11g, IEEE 802.11n
Frequency Range:	2400 MHz to 2483.5 MHz
Maximum EIRP:	Not more than 20 dBm

E-waste Guideline Manual



Introduction

We at Haler in our continuous efforts of training a future better adopted eco-friendly practices and procedures. We acting towards our social, moral and statutory responsibility towards the environment and sustainable development have pledged to recycle electronic items, such as TV, LED, LCD, refrigerator, AC, etc. that are no longer useful. Haler is stepping towards leading a more conservation and optimization of resources and thereby making environment safer. We request you to donate or utilize take back scheme for your electronic goods when it reaches its end-of-life, so that it can be reuse-recycle and reinvent.

Hazard of e-waste on environment and Human Health :-

The informal method of recycling extends health hazards. Primary and secondary exposure to toxic metals, such as lead, results in diseases like Heart, Liver, Lung & Spleen Damage. Open-air burning of electronic waste, used to retrieve valuable components such as gold, not only causes damages to environment but also to human health. Incineration from burning e-waste creates fine particulate matter,

which is linked to heart and respiratory disease. However, the above said is only example and the informal way to recycle causes numerous health hazards. During such informal recycling no caution or care are kept to either secure the environment or human health. The informal method of recycling extends environment hazards too. For example when different e-waste is burnt to extract metals from it, toxic chemicals are released in to the air, damaging the atmosphere. Such informal ways create noise, water and air pollution.

E-WASTE TOXIC COMPONENTS THEIR DAMAGE TO HUMAN HEALTH

Toxic Material	Ear Deform	Brain Damage	Heart, Liver, Lung & Spleen Damage	Liver Damage	Ferrous Bio-toxicity System Damage	Nerve System Damage
Barium	✓	✗	✗	✓	✓	✓
Cadmium	✗	✓	✗	✗	✗	✗
Lead	✗	✗	✓	✗	✗	✓
Lithium	✗	✗	✗	✗	✗	✓
Mercury	✗	✗	✗	✗	✓	✓
Nickel	✗	✓	✗	✗	✗	✓
Palladium	✗	✗	✗	✗	✓	✓
Rhodium	✓	✓	✗	✓	✓	✓
Silver	✗	✗	✗	✗	✗	✓

Without safe recycling, most of these toxic components will end in land fill-polluting soil and water.

Why proper handling and management of e-waste :-

The electrical and electronic equipment (EEE) have valuable materials and hazardous/toxic substances in their components. The electronic products and electrical equipment after their useful life may not cause any harm if it is stored safely in households stores. However, if the E-waste is opened up and attempts are made for retrieval of useful components or material in an un-scientific manner or if the material is disposed in open, then it may cause health risks and damage to environment. E-waste can be considered as a resource that contains useful material of economic benefit for recovery of plastics, iron, glass, aluminum, copper and precious metals such as silver, gold, platinum, and palladium and lead, cadmium, mercury etc. However, at the same time presence of heavy metals (As, Cd, Hg, Pb etc.) and other toxic substances such as polychlorinated biphenyls (PCBs), etched chemicals, etc. may pose risk to health and environment during handling and recovery operations. E-waste is a problem of increasing proportions especially when crude methods are adopted for recovery of useful components from E-waste.

Thus, there is a need to encourage OUR SELF for recycling of all useful and valuable material from e-waste so as to conserve the ever-depleting natural resources. Electronic component are increasingly made from recycled materials, for example for making new LCDs, more than 50% of indium is sourced by recycling used LCDs. The E-waste thus presents a scenario of urban mining for recovery of ferrous/non-ferrous/rare earth metal and precious metal in addition to plastics and glass. However, presence of hazardous and toxic substances in the component of e-waste necessitates environmentally sound management of e-waste including collection and recycling/treatment in an environmentally sound manner.

Management and Effect on sustainable future:-

Sustainable development as defined by Brundland Commission is "development that meets the needs of the present without compromising the ability of future generations to meet their own needs."

The e-waste since a long time had been seen as an easy and cheapest source of metals. However due to lack of proper consideration for such source of metals as well as proper methods of recycling in India, we sent our e-waste to the improper channel (scrap vendor) and thereby participated in degrading the environment. Moreover, through this improper method of extraction of metals we till date had wasted approximately 40% of the precious metals and simultaneously caused damage to our environment. If we opt the proper way to extract metals through proper channel of recycling then we can achieve approximately 90% of extraction rate of our metals as well as a better way to save our environment. However, if today while selling off our material to improper channel we will not think about our sustainable future then it is for sure that the coming generations will be facing costs of the metals.

Customer responsibility

- consumers shall ensure that their end-of-life product's waste is channeled through collection center or dealer of authorized producer or dismantler or recycler or through the designated take back service provider of the producer to authorized dismantler or recycler;
- consumers shall ensure that such end-of-life electrical and electronic equipment are not admixed with e-waste containing radioactive material.

Electronic Waste Recycling:

- Do's**
- Handover/Donate/Give the discarded Electronic Equipment's only at the authorized collection centers.
 - Drop the discarded Electronic Equipment's in the bins meant for the Electronic Waste.
 - Ask the retailer about the Take Back schemes.
 - Consult the authorized service center as to whether the Electronic Equipment can be repaired or not, before discarding the same.
 - Tell your neighbors and other persons about the hazards of improper disposal or handling or improper recycling of the Electronic Waste.
 - If the unwanted Electronic Equipment still work or can be repaired then consider donating them.
 - To minimize our impact on the earth and to protect the environment for future generations return your discarded Electronic Equipment's here for safe recycling.
- Don'ts**
- Don't dump the discarded Electronic Equipment's in open or in any Land Fill Site as the same will result in contaminating the Soil and the ground water.
 - Don't dispose of the discarded Electronic Equipment's in household bins or Municipal Bins.
 - Don't sell or give your discarded Electronic Equipment's to any Trash Dealer or Kazadiwala/Unauthorized vendor.
 - Don't try to open up the product by yourself for repair or other purposes.
 - Don't mix the electronic waste into household waste stream.
 - Don't keep any replaced spare parts from the product in exposed area. Always Handover such article to service personal so that same can be recycled.

